



INSTRUCTION BOOKLET

SUPER NINTENDO[®]
ENTERTAINMENT SYSTEM

WARNING: PLEASE CAREFULLY READ THE CONSUMER INFORMATION AND PRECAUTIONS BOOKLET INCLUDED WITH THIS PRODUCT BEFORE USING YOUR NINTENDO® HARDWARE SYSTEM OR GAME PAK.



This official seal is your assurance that Nintendo has reviewed this product and that it has met our standards for excellence in workmanship, reliability and entertainment value. Always look for this seal when buying games and accessories to ensure complete compatibility with your Nintendo product.

All Nintendo products are licensed by sale for use only with other authorized products bearing the Official Nintendo Seal of Quality™.

Thanks for selecting the F-ZERO™ Game Pak for your SUPER NINTENDO ENTERTAINMENT SYSTEM®.

Please read this instruction booklet thoroughly to ensure proper handling of your new game. Please save this booklet for future reference.

TABLE OF CONTENTS

CONTROLLER OPERATION.....	2
WHAT IS F-ZERO?.....	3
DETAILS OF CONTROLLER OPERATION	5
HOW TO PLAY THE GAME	7
F-ZERO OFFICIAL RULES	11
THE MACHINES & THEIR PILOTS.....	14
INTRODUCING THE SATELLITE CITIES & COURSES.....	18
TRACK FEATURES AND HAZARDS	20
THE STORY OF CAPTAIN FALCON	21
LAST, BUT NOT LEAST	29

TM and ® are trademarks of Nintendo of America Inc.
©1991 Nintendo of America Inc.

CONTROLLER OPERATION

For a detailed description on how to operate the controller, see pages 5 and 6.

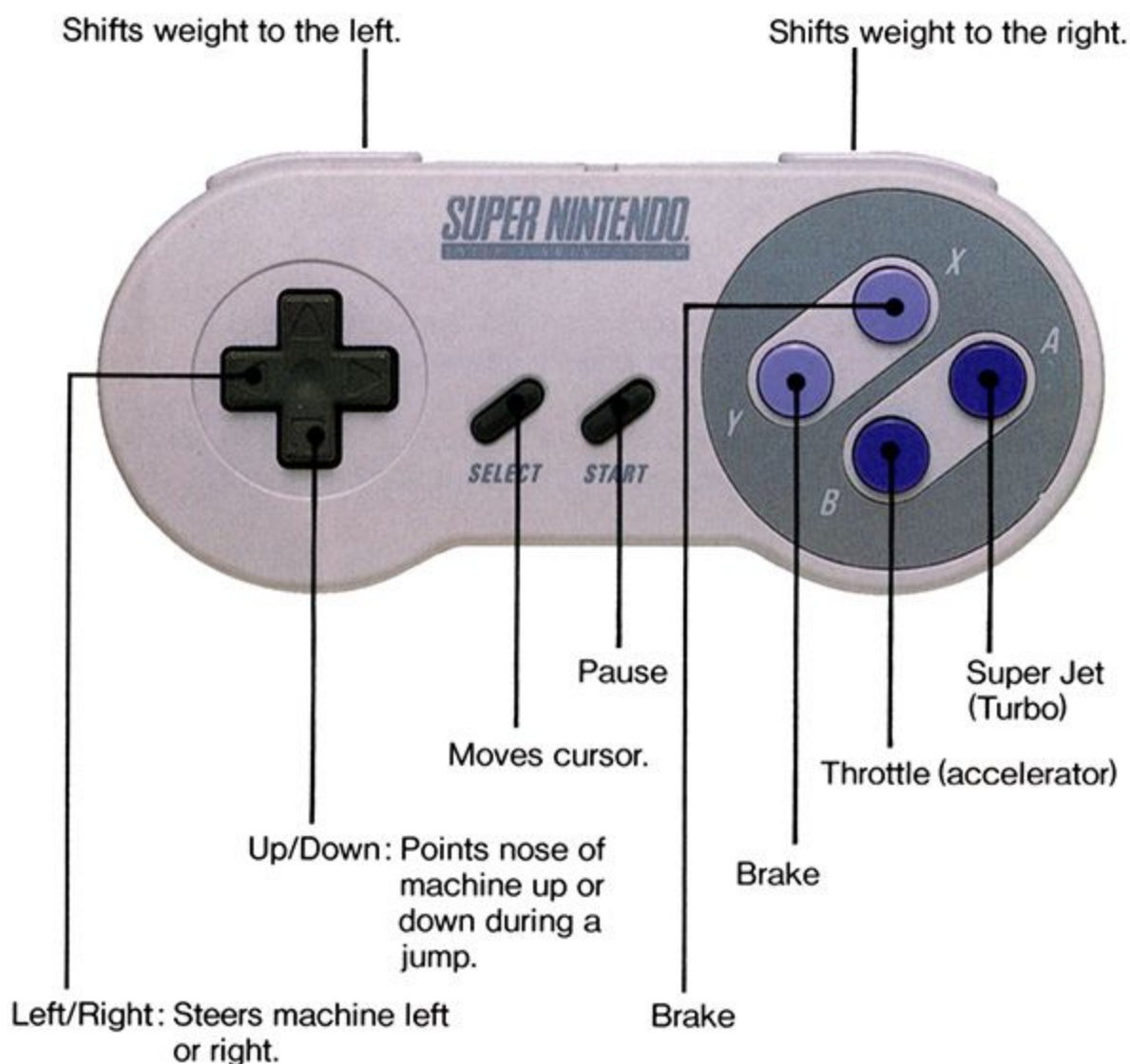

This Game Pak contains a function for storing race times, etc. If the POWER or RESET switch is repeatedly turned ON and OFF, data stored in the memory may be lost.

WHAT IS F-ZERO?

In the latter half of the 20th century, Mankind was gripped by the fear of being invaded by extraterrestrials. They referred to extraterrestrial spacecraft as UFOs (Unidentified Flying Objects). Now, to those of us in this day and age, this sounds like a fairy tale.

It is now the year 2560, and due to the human race's countless encounters with alien life forms throughout the Universe, Earth's social framework has expanded to cosmic proportions. Now, trade, technology transfer and cultural interchange are carried out on an interplanetary basis.

The multibillionaires who earned their enormous wealth through intergalactic trade, while satisfied with their rich lifestyles, also yearned for new entertainment to stimulate their lazy lives. Their wishes were met by a call for a new project based upon a seemingly simple premise—"Why not hold, on a galactic scale, some competition like the F-1 races once held on Earth centuries ago?"

At once, everyone jumped at this idea. Rich merchants from cities in the clouds or asteroids with almost uninhabitable environments invested their wealth in the construction of racing circuits.

These racing circuits were located as high up as 300 feet above ground and held in place by anti-gravitational guide beams on both sides of the course.

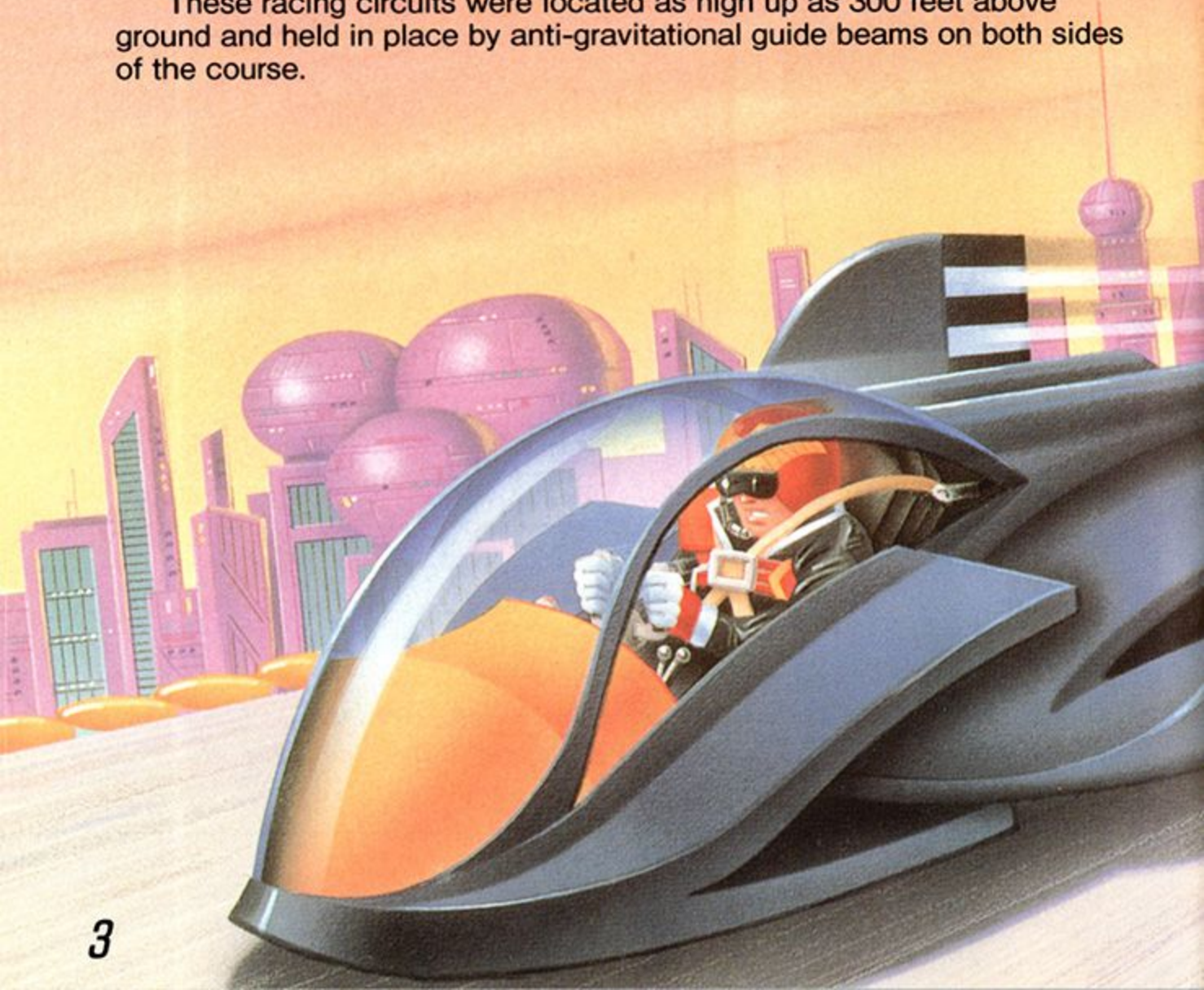

The racing machines developed for these tracks used the very latest in super-magnetic technology and were designed to travel without wheels, hovering one foot above the course track.

When the first Grand Prix race was held, people were angered at the brutality of the competition. The organizers had, during construction, placed various obstacles and traps along the raceway. But as time passed, and people grew used to these dangers, they soon demanded even more excitement in the race. In time, winning this race meant earning the highest honor that could be bestowed on anyone in the Universe.

In a very short time, people came to call this Grand Prix simply, "F-ZERO".

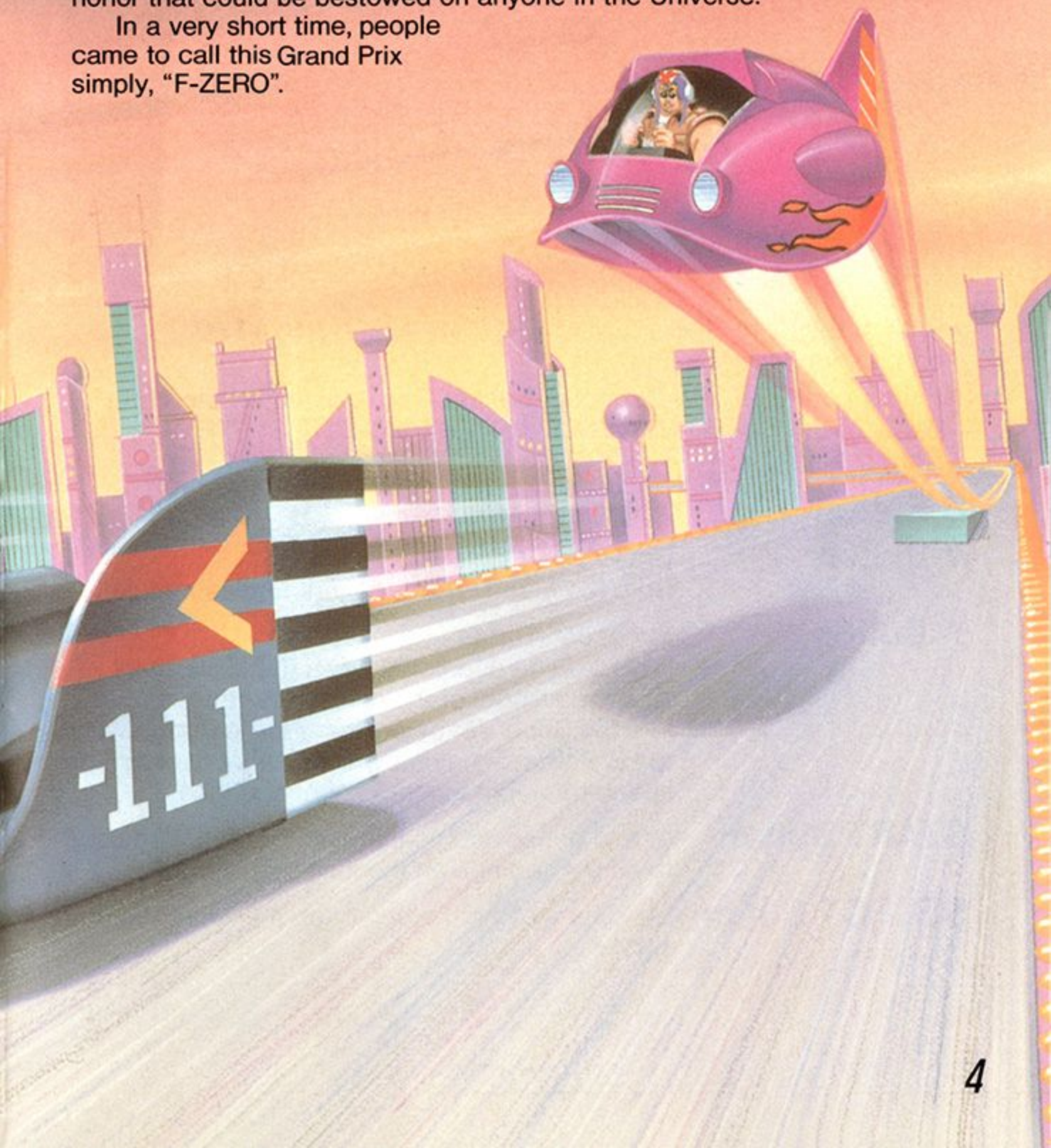

DETAILS OF CONTROLLER OPERATION

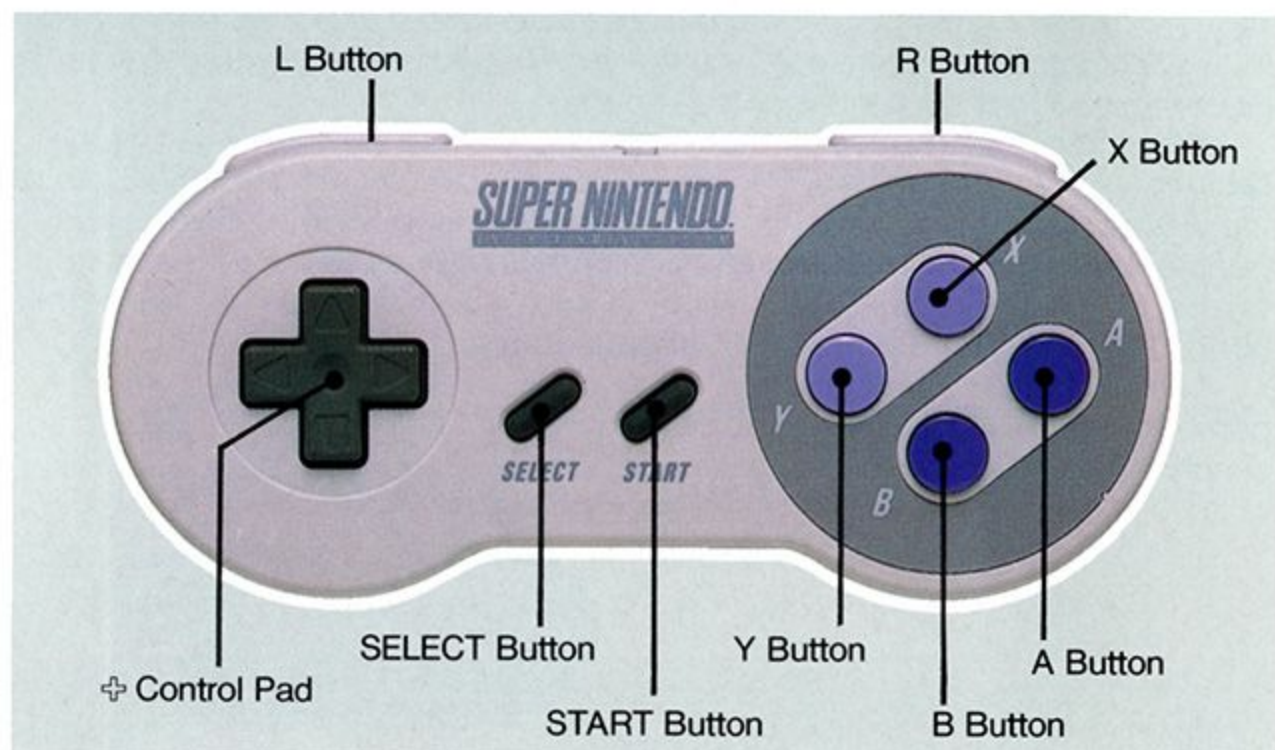

- Both of the SUPER NINTENDO ENTERTAINMENT SYSTEM controllers are the same.
- Plug a controller into Controller Socket One, located on the front panel of the SUPER NINTENDO ENTERTAINMENT SYSTEM Control Deck.

B Button

Throttle (Accelerator)

Y Button

Brake

Both the X and Y Buttons function as a brake.

A Button

Super Jet (Turbo)

(This may be used only when the "SSS" mark at the bottom right of the screen is shaded green. Fire the Super Jet by pressing the A Button while the B Button is held down. You will travel at high speed for approximately four seconds.)

START Button

Use to pause (stop game during play). Also used to adjust settings on the selection screen.

SELECT Button

Used for moving the cursor on the selection screen.

+ Control Pad

- Left/Right** Left/Right steering (rudder movement)
- Up** Points machines nose down, shortening the jump flight distance.
- Down** Points machines nose up, lengthening the jump flight distance.
(When the machine jumps from a jump plate on the race course)



L Button R Button

- Shifts weight, moving center of gravity to left.
- Shifts weight, moving center of gravity to right.
(This lets you move to the side (slide) while travelling forward. Shifting weight combined with rudder movement will allow you to cut into a corner even more deeply.)

This Game Pak contains a function for storing race times, etc. If the POWER or RESET switch is repeatedly turned ON and OFF, data stored in the memory may be lost.

HOW TO PLAY THE GAME

Insert the Game Pak into the SUPER NINTENDO ENTERTAINMENT SYSTEM Control Deck and turn the POWER switch ON. The Title screen shown on the right will appear. First select the game mode (GRAND PRIX or PRACTICE) using the SELECT Button or Up or Down on the \oplus Control Pad. Accept the Selection by pressing the START Button (or A or B Button).

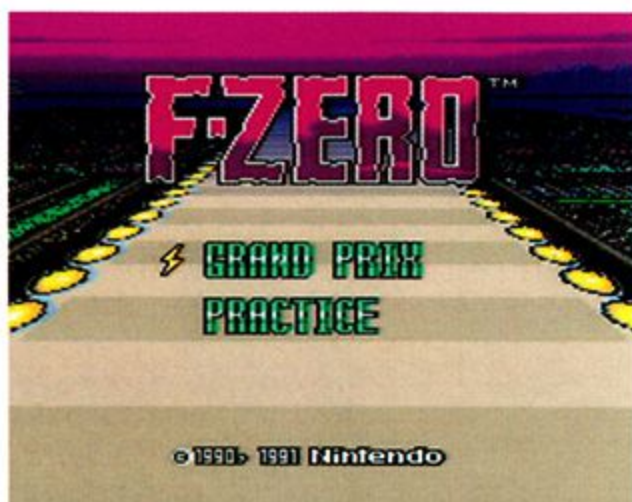

GRAND PRIX

First, move the cursor to select your machine. (For details on each machine's performance characteristics, see pages 14-17) To select a different machine, select NO at the bottom of the screen. This returns you to the previous screen. Next, select the League and Class in which you wish to race. Select one of the Leagues (KNIGHT, QUEEN or KING), and one of the Classes (BEGINNER, STANDARD, or EXPERT) using the SELECT Button or Up or Down on the \oplus Control Pad.



The level of difficulty of the Leagues and Classes are as follows.



► On the Screen

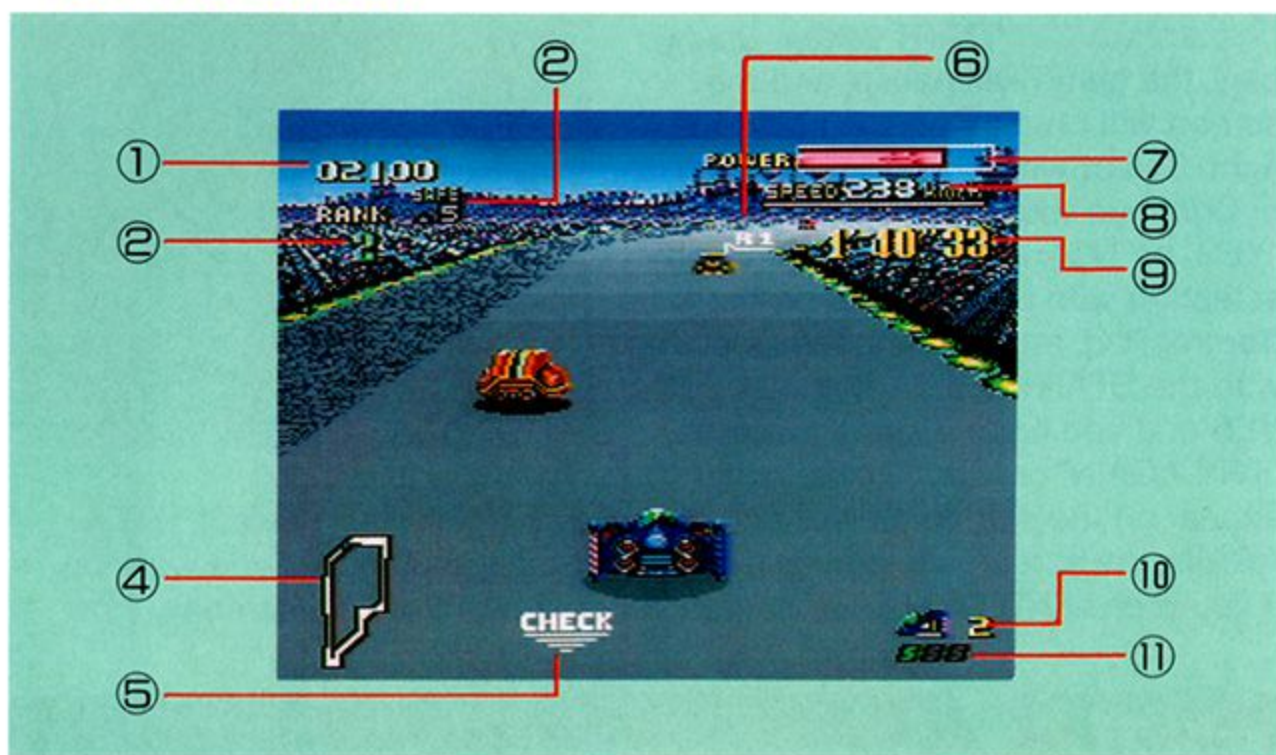

① Points Display

This displays your total number of points so far.

② Target Rank Display

If you fail to pass the Goal Line at this rank or higher, you will be disqualified.

③ Rank Display

This is your machine's current rank. If the current rank is below the target rank, the number will flash red and a warning buzzer will sound.

④ Course Layout

The dot on the course is the current position of your machine.

⑤ CHECK Marker

This displays the fact that you are being chased, and the machine is directly behind you.

⑥ Enemy Rank Marker

This shows the current rank of the machine in front of you.

⑦ POWER Meter

This meter decreases each time you bump into another machine or the guard rail. When your power level falls below a given amount, your machine's top speed will be reduced. When the meter indicates 0 ("zero"), your machine will be unable to withstand further contact. Any impact with another machine, or the guard rail will result in an explosion and you will "Crash Out" of the course.

⑧ SPEED Meter

⑨ Race Time Display

⑩ Number of Spare Machines

⑪ Super Jet Reserve

The Super Jet (turbo) can be used when green. No more than three uses of the Super Jet may be saved. The display changes to red when in use.

► GIVE UP

If you press the START button during play, the game will pause, and the screen will change as shown on the right. Select whether or not to Give Up or Continue the game by selecting "YES" or "NO", respectively. (Do this by selecting with Left or Right on the + Control Pad, and entering the selection with the START Button. If you select YES and you have a spare machine, "TRY AGAIN" or "END GAME" will appear on the screen. Select one of these choices. If you select TRY AGAIN, the screen will return to the start of the course that you were on. If you press END GAME, the screen will return to the Title screen.



PRACTICE

This is a practice game mode containing seven of the courses from the GRAND PRIX mode. After you have selected your machine, next select the rival machine you are to race against. If you do not want to race against a rival, select "NO RIVAL". (Your rival's speed increases in the following order: BLUE FALCON, GOLDEN FOX, WILD GOOSE, and FIRE STINGRAY.) No machine's other than the rival machine that you have chosen will appear in this mode. The game will start once you have chosen the course on which you wish to travel (by using the SELECT Button or Up or Down on the + Control Pad). After you have travelled five laps, you will view your lap time, total time and the best five course times so far. After completing the course (or when you have given up), you may try the same race again, end the current game, choose a new course, or change to a different machine or rival as shown on the screen below.



RECORDS

If you make a new record in either the GRAND PRIX or PRACTICE modes, this screen will appear. In this mode, the best ten times and laps for the courses completed so far from all of the 15 courses will be recorded and displayed. Records underlined in red are GRAND PRIX records, while records underlined in green are PRACTICE records. Times are recorded automatically when the lap times are allowed to be completely displayed after the course is completed. If the SUPER NINTENDO ENTERTAINMENT SYSTEM® is reset while doing this, the time may not be recorded.

To erase all records in each of the courses, press the SELECT Button at the RECORDS screen. This will display the message "ERASE? YES/NO". Select YES and press the START Button.

(Records are saved to the Game Pak's battery backed memory even when the power is turned OFF.)



F-ZERO OFFICIAL RULES

These are the nine official rules of Grand Prix Racing as laid down by the F-ZERO Executive Committee. F-ZERO pilots must observe these rules when participating in sanctioned racing.

- 1** The goal is to complete each course, finishing as one of the top three pilots for all five courses within each League circuit.
- 2** In a single course, machines vie for ranking over five laps. Each lap must be completed within a fixed target rank or disqualification will occur.

1st LAP	Pass the Goal Line within 15th place.
----------------	---------------------------------------

2nd LAP	Pass the Goal Line within 10th place.
----------------	---------------------------------------

3rd LAP	Pass the Goal Line within 7th place.
----------------	--------------------------------------

4th LAP	Pass the Goal Line within 5th place.
----------------	--------------------------------------

FINAL LAP	Ranked within the top three finishers.
------------------	--

If you do not meet these conditions, you will be disqualified.

- 3** If you are disqualified, crash out of the course, or retire, you may re-challenge that course only if you have a spare machine.
Note: You may use only two spare machines at the start of the Grand Prix. (See Rule 4, The Points System.)

4 The Points System

During participation in a single race of each League in the Grand Prix, the points listed below are given to the pilots according to their ranking at the end of each of the first four laps.

RANK 1	900pts
---------------	---------------

RANK 2	600pts
---------------	---------------

RANK 3	400pts
---------------	---------------

4th place or below	200pts
---------------------------	---------------

(Pilots do not receive points if they do not meet the target rank for each lap. See Rule 2.)

Points are awarded as follows for the final lap.

1st PLACE	2500pts
2nd PLACE	1500pts
3rd PLACE	1000pts

Also, each time your total score reaches 10,000 pts, 20,000 pts, or 30,000 pts, you are awarded an additional spare machine. You are only allowed to keep a total of 5 spare machines.

5 About Super Jet

Use of Super Jet (S-JET) is not allowed in the first lap of each course. This is to decrease the probability of collisions at the start of the race. Pilots are allowed to use S-JET once each time a lap has been completed. It is solely up to the discretion of the pilot at which point of the course he uses the S-JET. A maximum of three uses of the S-JET may be accumulated per race.

- 6** It is extremely dangerous to travel the course in the direction opposite to the flow of traffic. If this occurs, "REVERSE" will be displayed accompanied by a warning buzzer. Pilots must quickly turn their machines around to travel in the correct direction.



7 Short Cut Fouls

Some short cutting is allowed, such as flying outside of the course to gain distance at curves, etc. by use of a jump plate. However, the official recorder may rule an extreme short cut to be a foul, and you may be subject to being pulled back to any position at the recorder's discretion.



8 About Pit Runs

In each course, a Pit Row area is provided at fixed areas near the home straight or nearby. Machines can have their power restored from the official car only when within the designated Pit Row area. The amount of power that will be transferred to your machine is proportional to the time that you spend within the Pit Row area. To receive maximum power it is advisable that Pit Runs be made at a slow speed.



9 Special Rule in Variance to Rule 2:

This rule is limited only to the following four machines: BLUE FALCON, GOLDEN FOX, WILD GOOSE, and FIRE STINGRAY. If any of these machines fall below the rank of 20th place at any time during the race, they will be subject to immediate and compulsory disqualification by the official recorder.

THE MACHINES & THEIR PILOTS

THE BLUE FALCON

Made by: Unknown
Engine: BF-2001 x 4
Max. Horsepower: 3,200 PS
Max. Speed: 457 km/h
Total weight: 1,260 kg
Pilot: Captain Falcon

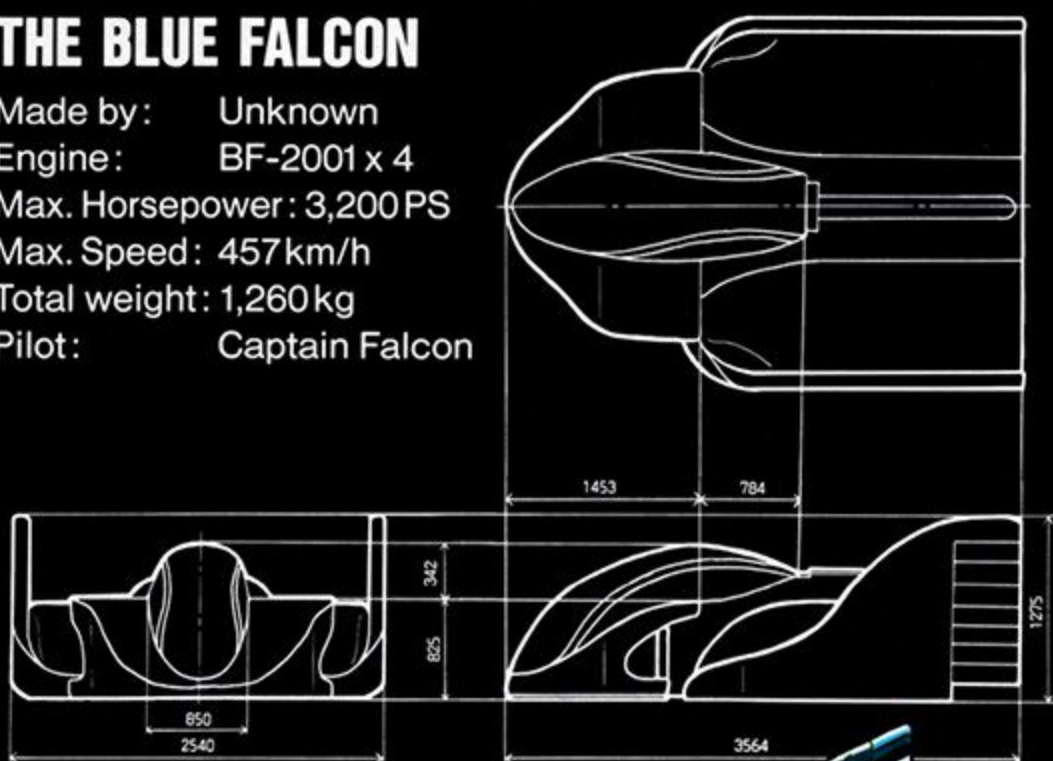

This machine has been given a complete, well-balanced tuning by Captain Falcon. Even beginners will be able to skillfully drive the machine after only a little practice.

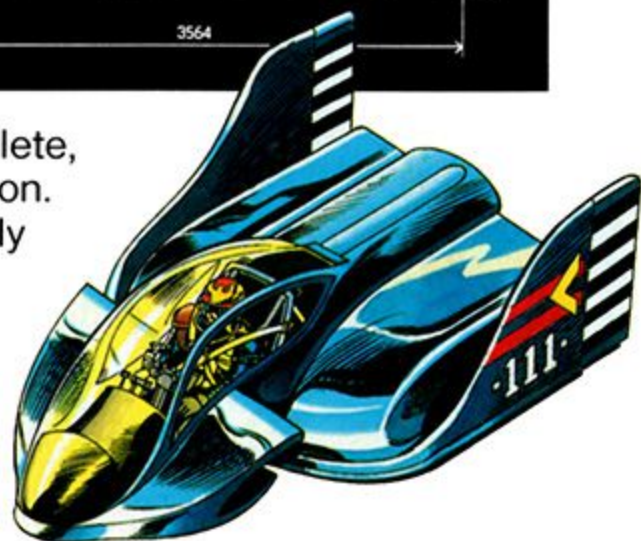

CAPTAIN FALCON

From Port Town. Age unknown. (Rumored to be in his early 30's.)

Besides being an accomplished F-ZERO pilot, he is a renowned and talented bounty hunter. Not much is known about his past.

GOLDEN FOX

Made by: Kevin Stuart
Engine: GF-2614 x 4
Max. Horsepower: 2,950PS
Max. Speed: 438 km/h
Total weight: 1,020 kg
Pilot: Dr. Robert Stuart

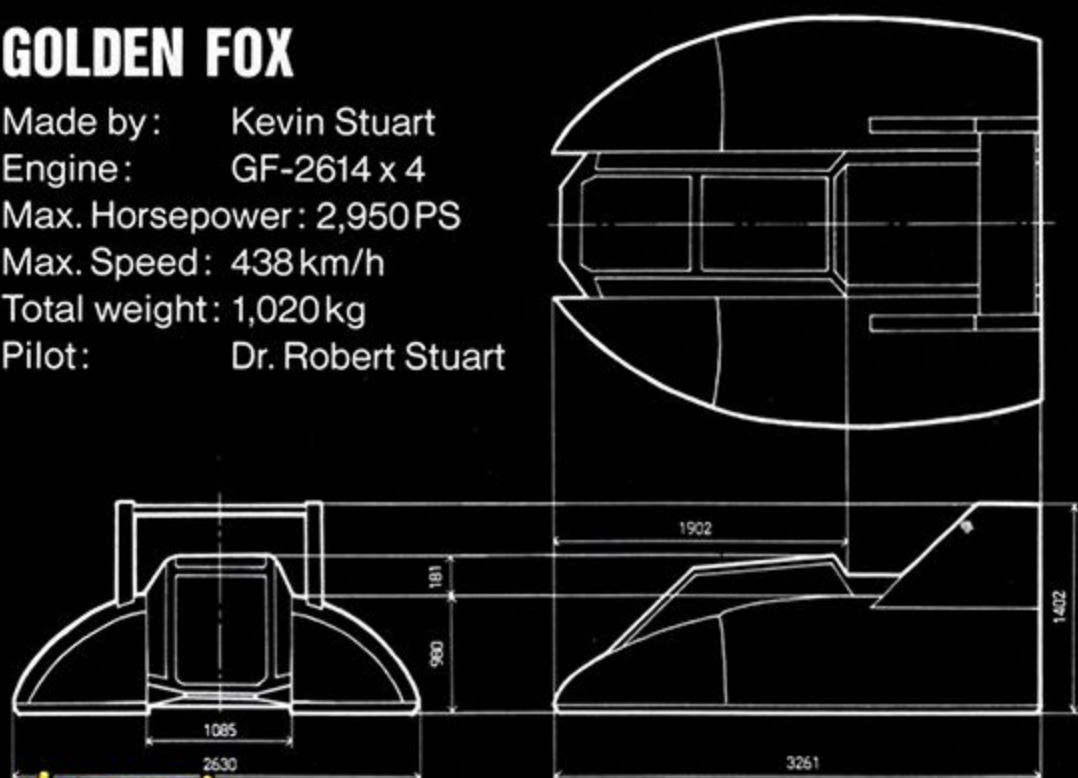

During the design and construction of this machine, its developer, Kevin Stuart (now deceased), gave priority to acceleration. In compensation for its power output, the body was made to be light to reduce the G force on the course surface.

This characteristic makes it difficult to strike a good balance between turning and

engine power, resulting in difficult cornering. It is an undeniable fact that the Golden Fox stands up poorly to impact. Pilots using this machine are required to have a high level of skill.

Dr. STUART

From Mute City. Full name: Robert Stuart.

Age: 31.

Though he had followed the lifestyle of the elite as an accomplished and well respected medical doctor, he has participated in the F-ZERO Grand Prix as the pilot of the Golden Fox since the death of his father the scientist, Professor Kevin Stuart.



WILD GOOSE

Made by: Sergeant Lipot
Engine: ES-8302 x 3
Max. Horsepower: 3,670PS
Max. Speed: 462 km/h
Total weight: 1,620kg
Pilot: Pico

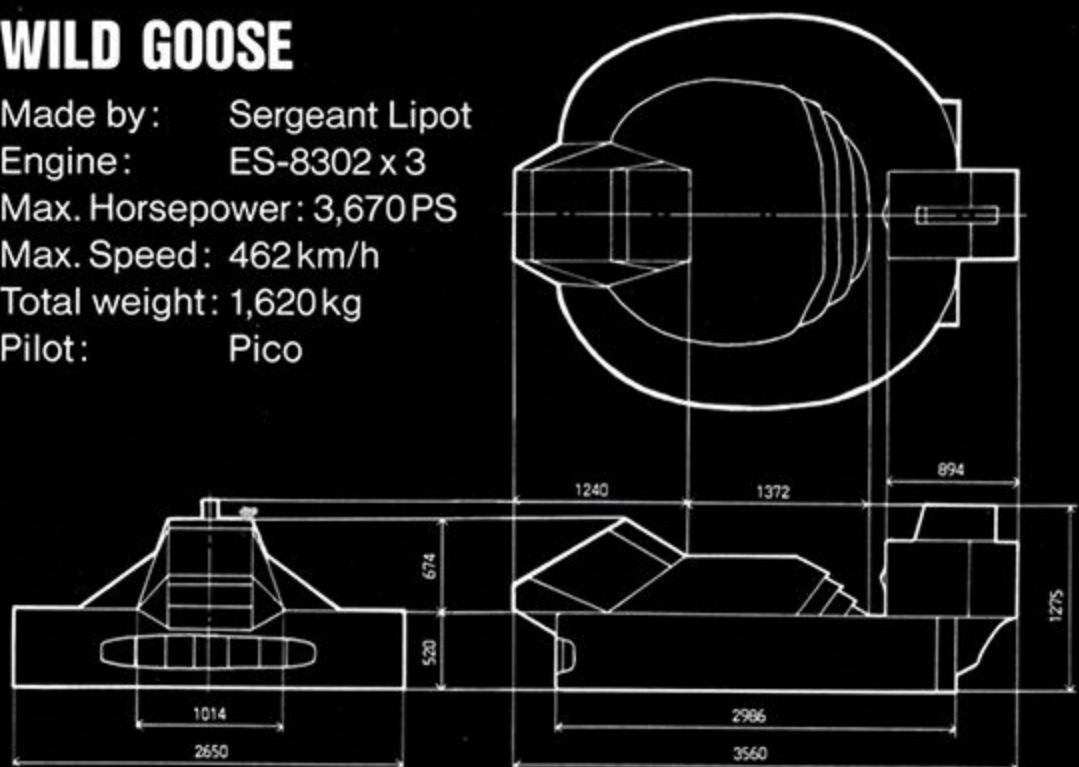

This machine is designed to withstand very heavy damage. The primary purpose of its design was to allow it to run using a highly aggressive racing style. The soldier who designed The Wild Goose is a member of the Polipoto tribe of Death Wind—a tribe with a strong fighting spirit.



PICO

From Death Wind. Age: 34. Believed to be an ex-soldier who worked in the Polipoto Army's Special Fighting Unit. He is a highly aggressive pilot, and his cold heart is a perfect complement to this. Officially, his occupation is an F-ZERO pilot, but, it is rumored that he is also a competent hit-man.

FIRE STINGRAY

Made by: Unknown
Engine: RS-5025 x 2
Max. Horsepower: 3,800 PS
Max. Speed: 478 km/h
Total weight: 1,960 kg
Pilot: Samurai Goroh

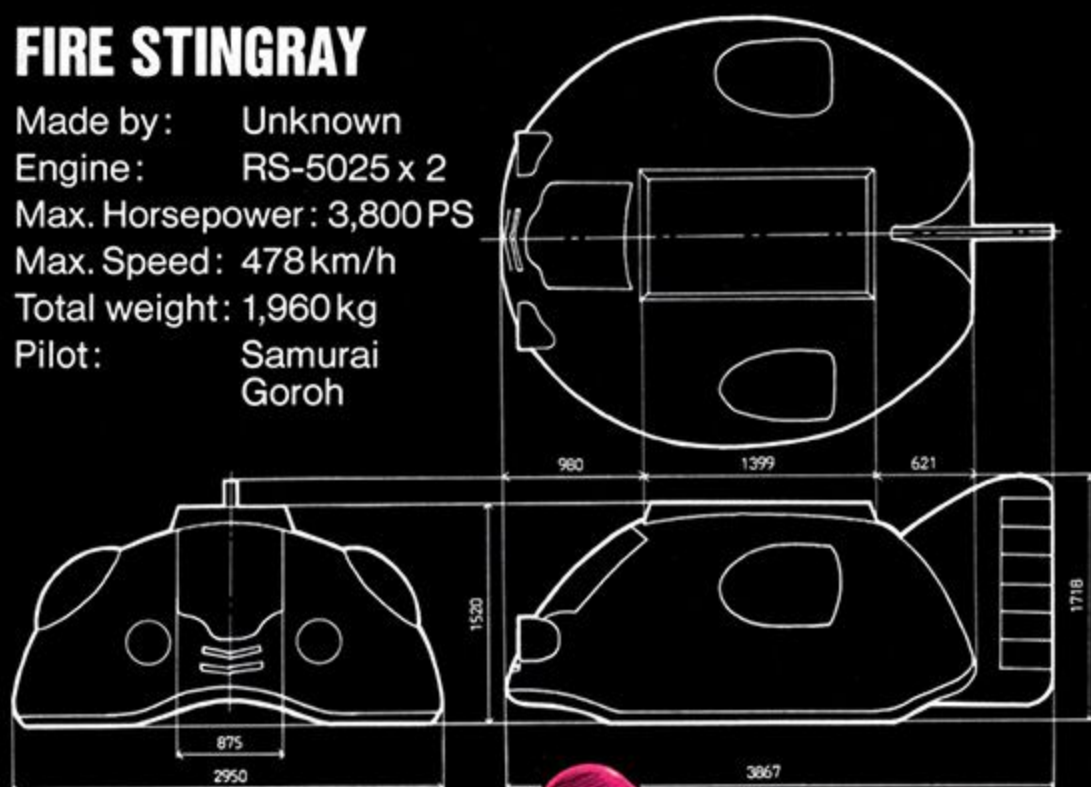

This machine has two RS-5025 engines, the pride of the Universe. It is a heavy-bodied machine and accelerates very slowly. This machine has recorded the fastest speed of the four main machines. Careful and perfectly-timed use

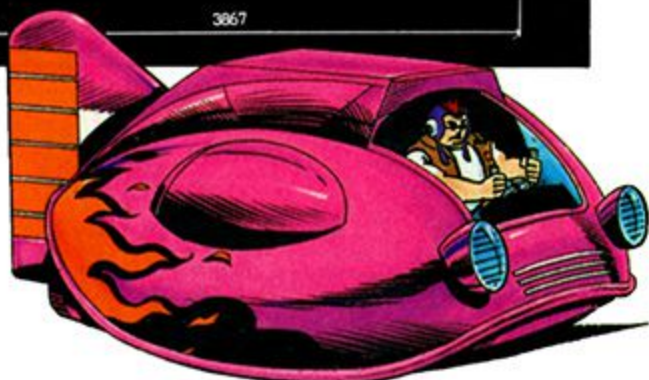

of the S-JET is a key point in the operation of this machine. It is also highly rated for its stability while cornering.



SAMURAI GOROH

Birthplace: Unknown (believed to be Japanese American)
Age: Unknown (believed to be early 40's)
The leader of a renegade band of thieves known to hide out in Red Canyon. It is known that he participates in the Grand Prix under an alias, and it is also rumored that this machine is stolen property.

INTRODUCING THE SATELLITE CITIES & COURSES

In the F-ZERO Grand Prix, 15 courses are located on nine planets spread throughout the universe. The descriptions below are for the seven courses to be found in the PRACTICE mode.

1. MUTE CITY

This is the biggest city on all of the Space Federation Planets. Mute City has prospered from intergalactic trade and boasts a population of more than 200 million. Its original name was Mutant City. The opening race of all three Leagues of the F-ZERO Grand Prix is held here.



Knight League No.1

2. BIG BLUE

99% of this planet's surface is covered in water. The final corner of this course has been given a special coating that blocks magnetic fields. Pilots must take care not to slide out of control here.



Knight League No.2

3. SAND OCEAN

The entire surface here is covered in dunes. In ancient days, primitive animals lived on this planet, however, now only their fossilized remains can be found. This course requires high level driving techniques. Take care in the sharp corners by cleverly deciding on the right line to follow.



Knight League No.3

4. DEATH WIND

The most peaceful place in the universe, a planet where fierce winds blow without respite. Though this course has been simply designed, it is narrow and difficult to travel along, due to severe side winds. Often, winning or losing is decided by how skillfully a pilot is able to use the dash zones.



Knight League No.4

5. SILENCE

A truly soundless planet, where not even a single noise can be heard. Designated as the final course for the Knight League, this course is made up almost entirely of right-angled corners. It is truly a test of a pilots' judgement and technique in cornering.



Knight League No.5

6. WHITE LAND

Covered in crystals, this is the most romantic planet in the Universe. This extremely demanding course has two hairpin corners that have been coated to block out magnetic fields, and downward pull magnets planted near its jump plates.



Queen League No.4

7. PORT TOWN

This is a harbor town that has been a relay point for intergalactic trade since times gone by. It is renowned among the pilots as the most technically demanding of all courses. As well as having left and right pull magnets, forced deceleration zones, tight chicanes and other traps, it also has a wide variety of corners.



King League No.3

TRACK FEATURES AND HAZARDS

► Rough

There are many types of Rough that will deprive your machine of its speed and interfere with its handling. The effect of the Rough will be a little different, depending upon that machine's individual characteristics. When you are caught in the lightest Rough areas, and using your Super Jet (turbo), you should almost be able to maintain your speed and break free. However, if you drive into the heaviest, or most concentrated areas of Rough, it is inevitable that you will lose some speed before you are able to break free. It is advisable to avoid driving through these zones.

► Anti-Gravity Guide Beam

This guard rail is installed to prevent machines from leaving the course and dropping over the edge. Be careful! If you touch it, it will cause your power meter to drop.

► Land Mines

Striking one of these will cause your power meter to take a huge drop, and will often cause a complete loss of control. As it is definitely a high-risk area, you should take great care when driving through a minefield.

► Jump Plate

This spring board will launch your machine high up into the sky. Except when you are already at full speed, your speed will increase as you fly through the air. Be careful when flying above the course, as improper landings will cause a loss of speed. It is advisable to take great care while airborne, as sloppy handling will cause the loss of your machine if it flies over the Anti-Gravity Guide Beam.

► Down-pull Magnets

Passing over these magnets that are arranged in banks, while flying above the course (after hitting a Jump Plate) will cause your machine to lose altitude and will cut your jump short. **WARNING!** Attempting to pass over one of these while not airborne, will cause your machine to come in direct contact with the track surface, resulting in a loss of speed and power.

► Left-Pull and Right-Pull Magnets

Designed using the same theory as the Down-Pull magnets, these are placed at the edge of the track and will cause your machine to be pulled off course. Pass these by steering in the opposite direction.

► Magnetic Field Block Coat

Also known as the Slip Zone. It is important to keep control of your machine when passing through this area, as this coating blocks your machine's magnetic grip on the track. It is important to remember that while driving through this area, your machine will be running on momentum.

► Dash Zone

Upon entering this zone, your machine will be thrust forward with an explosion of acceleration for a short period of time.

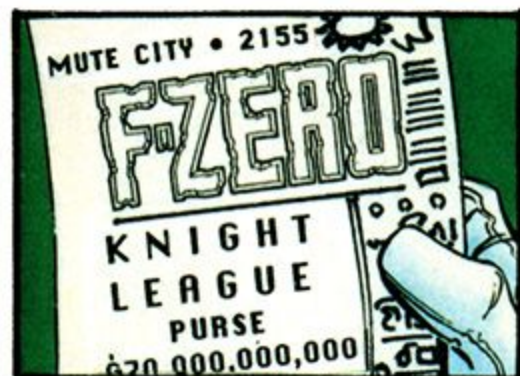
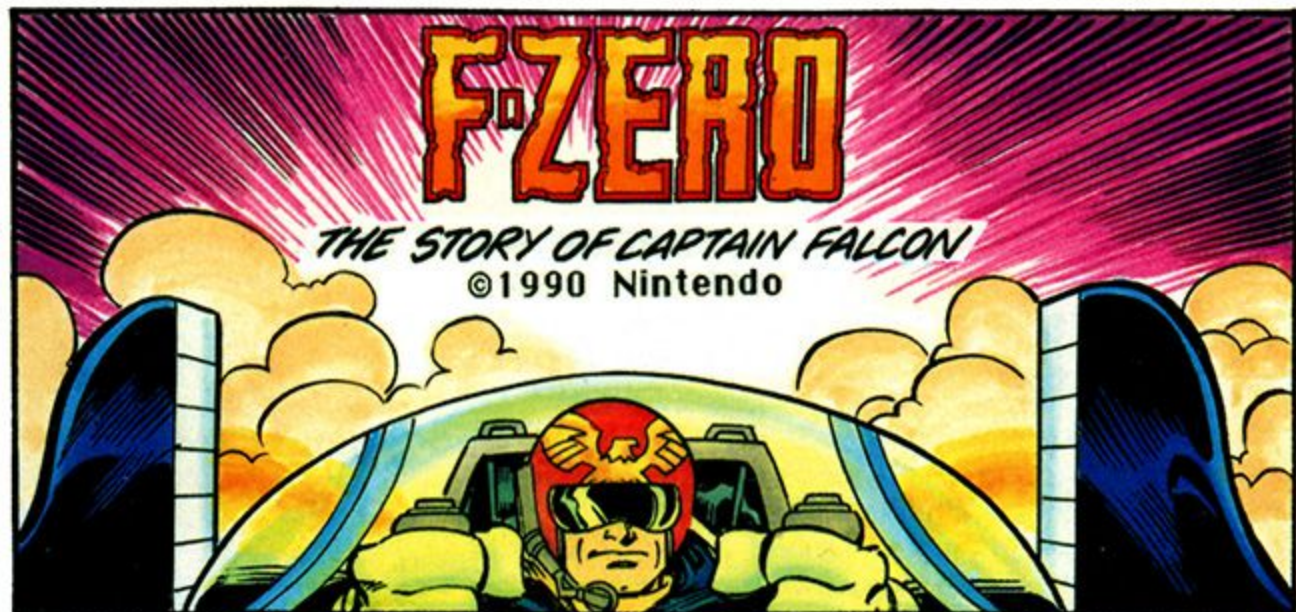
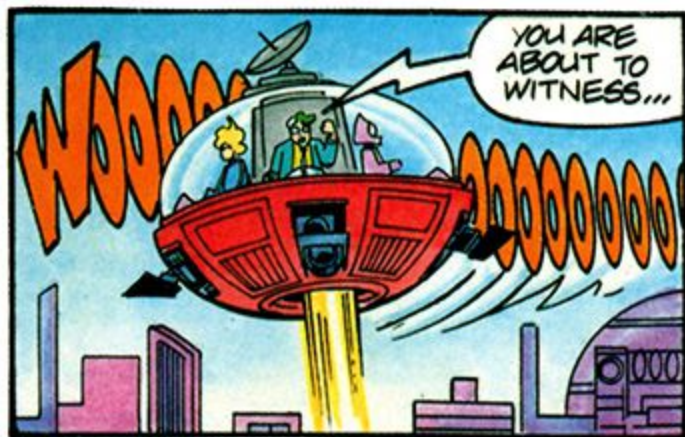

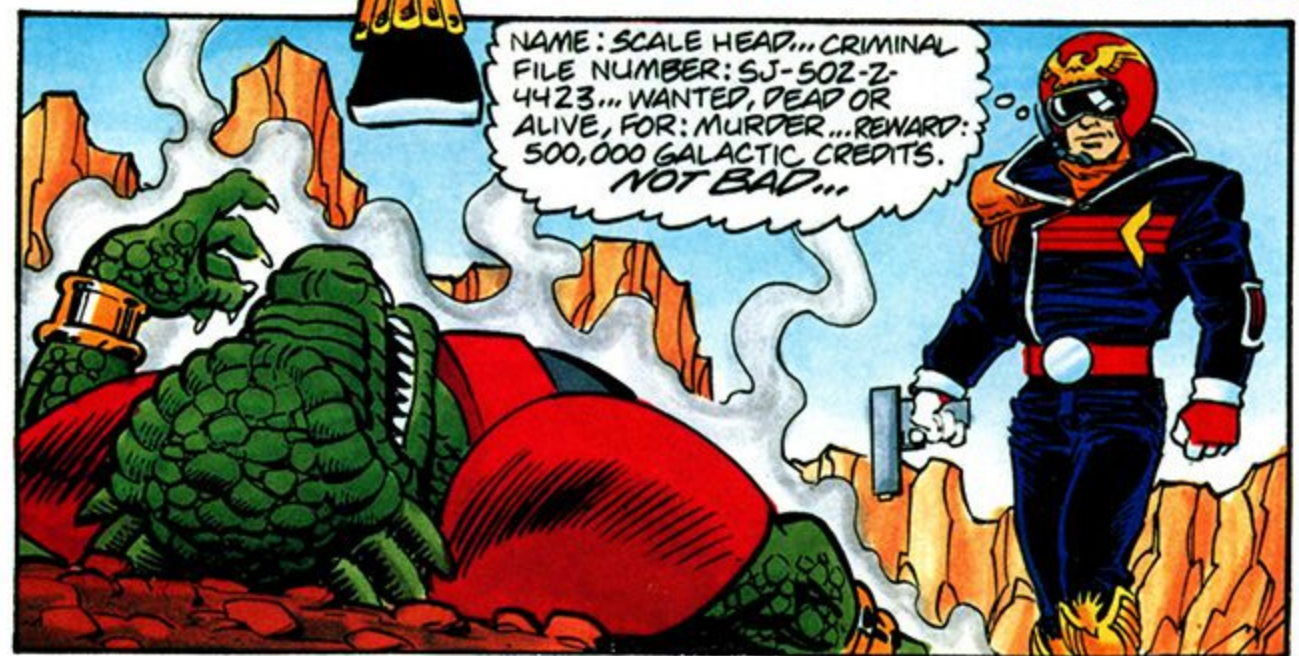

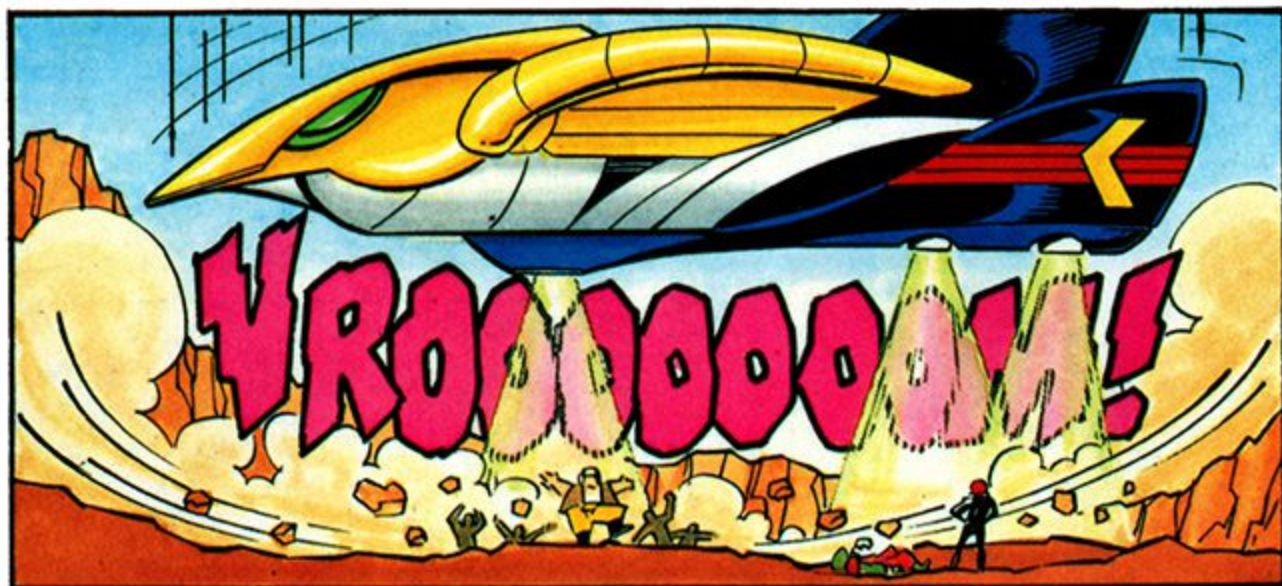

SOON...

MUTE CITY.





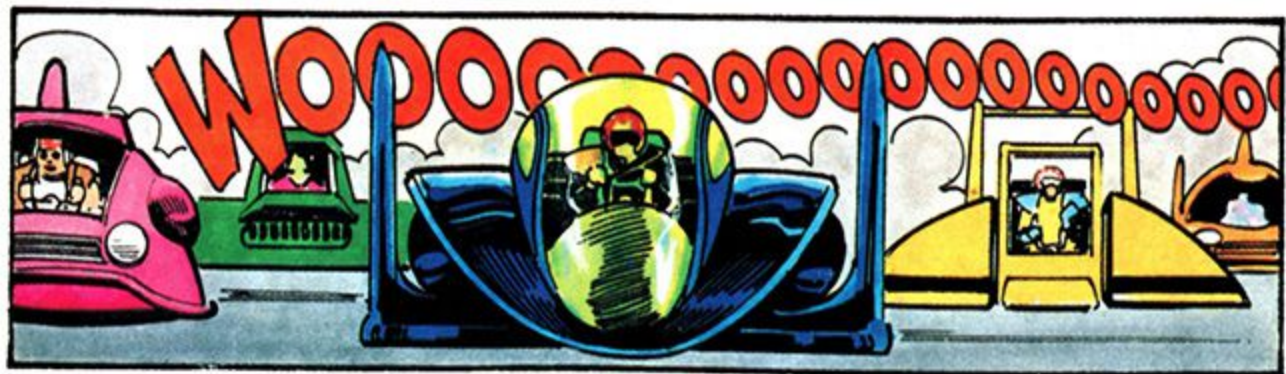

STA

THIS IS NO
GAME. MY BUTT
IS ON THE
LINE!

NOW YOU'LL
LEARN HOW MEN
DO BATTLE!

-11

RT!!!

**I HATE
LOSING TO
ANY DRIVER
WHOSE BLOOD
IS RED!**

**I SHALL WIN
TO HONOR BEAUTIFUL
WOMEN EVERYWHERE!**

TO BE CONTINUED... PUSH START!!

LAST, BUT NOT LEAST...

If you start the race with the throttle (B Button) held down, you will start off with a powerful dash. However, after the initial boost there will be a momentary stall from which it takes time to begin to accelerate again.

During a jump, your machine will accelerate as it travels above the course. So, to get the best speed, do not avoid the jump plates. (Take care, however, to prevent your machine from leaving the side of the course and falling to a crash landing far below!)

When landing after a jump, press Down on the \oplus Control Pad to tilt the nose of your machine upward. This prevents the impact shock of landing from decelerating your machine.

If a rival machine approaches you from behind you will be alerted by the CHECK mark. Watch for your opportunity to block it from overtaking you.

If your machine loses its stability and begins to slip or slide you should momentarily release the Throttle (B Button) to restore the machine's grip.

The game will be much more impressive if you listen to its sounds in stereo. For this, we recommend using a stereo AV cable for connecting the SUPER NINTENDO ENTERTAINMENT SYSTEM® to your TV.



THERE ARE TWO
KINDS OF DRIVERS
IN THIS RACE--ME
AND THE LOSERS!

90-DAY LIMITED WARRANTY

90-DAY LIMITED WARRANTY

Nintendo of America Inc. ("Nintendo") warrants to the original purchaser that this product shall be free from defects in material and workmanship for a period of 90 days from the date of purchase. If a defect covered by this warranty occurs during this 90-day warranty period, Nintendo will repair or replace the product or component part, at its option, free of charge.

WARRANTY SERVICE

To receive this warranty service:

1. **DO NOT** return your product to the retailer.
2. Please call Nintendo's **WORLD CLASS SERVICEsm** Center at 1-800-255-3700. Our hours of operation are from 4:00 am to Midnight, Pacific Time Monday through Saturday, and from 8:00 am to 5:00 pm, Pacific Time Sundays (times subject to change). If the Nintendo Service Representative is unable to solve the problem over the telephone, you will be referred to the nearest Nintendo **WORLD CLASS SERVICEsm** location for prompt, professional warranty service.

To satisfy the needs of our customers, Nintendo maintains a nationwide network of **Authorized WORLD CLASS SERVICEsm CENTERS** located in major metropolitan areas and also offers express factory service. In some instances it may be necessary to ship the complete product, **FREIGHT PREPAID AND INSURED FOR LOSS OR DAMAGE** to the nearest service location.

This warranty shall not apply if the product has been damaged by negligence, accident, commercial use, unreasonable use, modification, tampering, or by other causes unrelated to defective materials or workmanship. This warranty shall not apply if any product serial numbers have been altered, defaced, or removed.

WARRANTY LIMITATIONS

ANY APPLICABLE IMPLIED WARRANTIES, INCLUDING WARRANTIES OF MERCHANTABILITY AND FITNESS FOR A PARTICULAR PURPOSE, ARE HEREBY LIMITED TO NINETY DAYS FROM THE DATE OF PURCHASE AND ARE SUBJECT TO THE CONDITIONS SET FORTH HEREIN. IN NO EVENT SHALL NINTENDO BE LIABLE FOR CONSEQUENTIAL OR INCIDENTAL DAMAGES RESULTING FROM THE BREACH OF ANY EXPRESS OR IMPLIED WARRANTIES.

The provisions of this warranty are valid in the United States only. Some states do not allow limitations on how long an implied warranty lasts or exclusion of consequential or incidental damages, so the above limitation may not apply to you. This warranty gives you specific legal rights, and you may have other rights which vary from state to state.

REPAIR/SERVICE AFTER EXPIRATION OF WARRANTY

To receive service after the expiration of your warranty:

- 1) Please call Nintendo's **WORLD CLASS SERVICEsm** Center at 1-800-255-3700. Our hours of operation are from 4:00 am to Midnight, Pacific Time Monday through Saturday, and from 8:00 am to 5:00 pm, Pacific Time Sundays (times subject to change). If the Nintendo Service Representative is unable to solve the problem over the telephone, you will be referred to the nearest Nintendo **WORLD CLASS SERVICEsm** location for prompt, professional repair and replacement components.

To satisfy the needs of our customers, Nintendo maintains a nationwide network of **Authorized WORLD CLASS SERVICEsm CENTERS** located in major metropolitan areas and also offers express factory service. In some instances it may be necessary to ship the complete product, **FREIGHT PREPAID AND INSURED FOR LOSS OR DAMAGE** to the nearest service location.

**NEED HELP WITH INSTALLATION, MAINTENANCE
OR SERVICE? CALL 1-800-255-3700.**



Nintendo of America Inc.
P.O. Box 957, Redmond, WA 98073-0957 U.S.A.

PRINTED IN JAPAN